

CHARACTERISTICS

		STANDARD	AVAILABLE OPTIONS
Technology		Eccentric Disc Mouvex®	
Maximum Flow rate at 1 cst (l/h / GPM)		1000 / 4.4	
Cubic capacity (l / cu.in)		0,017 / 1.0374	
Inlet chamber volume (l / cu.in)		0,43 / 26.2	
Outlet chamber volume (l / cu.in)		0,16 / 9.8	
Ports		DN 40 ISO PN16 flanges	BS4825-5 (RJT) ISO PN20 flanges DIN 11864 BF-A Aseptik fl. SMS38 (SMS 1145) CLAMP ISO38 (ISO 2852) CSF (Connect S) BS4825-5 (RJT)
Pump heating		None	Heating jacket
Motor Flange		IEC FT130-B34	NEMA145TC, Foot bracket
Dimensions (mm / in.) (With ISO PN16 flanges)	L	459.5 / 18.091	
	H	240 / 9.449	
	C	229.5 / 9.035	
	E	105 / 4.134	
Weight (kg / lbs)		23 / 51	

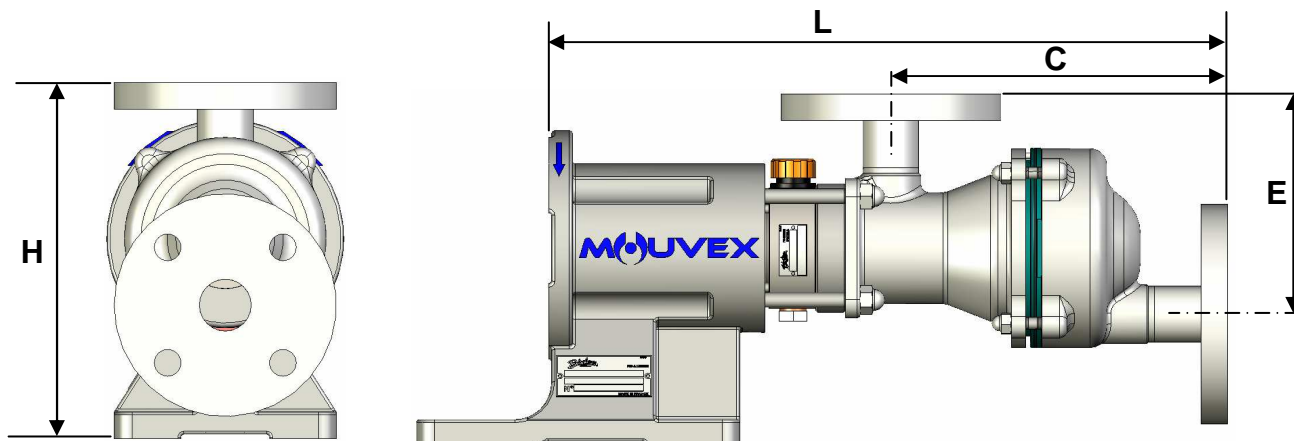

OPERATING LIMITS

	STANDARD MATERIALS
Minimum temperature °C /°F	-5 / 23
Maximum temperature °C /°F	Process: 110 / 230 Washing / Rinsing / Sterilisation : 121 / 250
Maximum viscosity (cst / SSU)	2000 (10000)
Maximum differential pressure (bar / psi)	16 / 232
Maximum inlet pressure (bar g/psig)	1.5 / 21.7
Maximum speed (rpm)	1000
Maximum solid particle size (mm/in)	2 / 0.079
Maximum soft particle size (mm/in)	4 / 0.157

MATERIALS OF CONSTRUCTION

Part No	PART NAME	STANDARD MATERIALS	AVAILABLE OPTIONS
100	Inlet Tube	316L Stainless Steel (low carbon)	
201	Cylinder	316L Stainless Steel (low carbon)	
301	Disc	Acteon (A494/A494M)	
309	Disc Nut	316Ti Stainless Steel (Titanium Alloy)	
400	Outlet Cover	316L Stainless Steel (low carbon)	
	Bolts	316L Stainless Steel (low carbon)	
781	Adaptor Flange	Cast Iron	
	Transmission Assembly		
596	Bearings	Ball / Roller / Needle	
	Bellows Assembly	316Ti & 316 L Stainless Fabrication	
	Housing	316L Stainless Steel	
	Screws	Steel	
	Transmission Lubricant	Synthetic oil	
	Seal Rings	Fluorocarbon (FKM) O-Rings	PTFE Encapsulated O-rings

