

### CHARACTERISTICS

	STANDARD	AVAILABLE OPTIONS
<b>Technology</b>	Vane pump	
<b>Maximum Flow rate at 1 cSt m<sup>3</sup>/h (GPM)</b>	15 (66) at 1000 rpm	
<b>Cubic capacity L (cu.in)</b>	0.29 (17.7)	
<b>Internal relief valve</b>	Single	Double, no relief valve
<b>Rotation</b>	Clockwise (6 vanes)	Anticlockwise, reversible (12 vanes)
<b>Ports</b>	ISO PN16 Flanges	
<b>Heating</b>	-	Heating jacket
<b>Dimensions mm (in.)</b>	<b>A</b> 101 (3.98)	
	<b>B</b> 316 (12.44)	
	<b>C</b> 62.5 (2.46)	
	<b>D</b> 125 (4.93)	
	<b>E</b> 112 (4.41)	
	<b>F</b> 323 (12.72)	396 (15.6) with double relief valve
	<b>G</b> 327 (12.87)	281.5 (11.09) without relief valve.
	<b>H</b> 250 (9.84)	
<b>Weight kg (lbs)</b>	41 (90.4)	38 (84) without relief valve

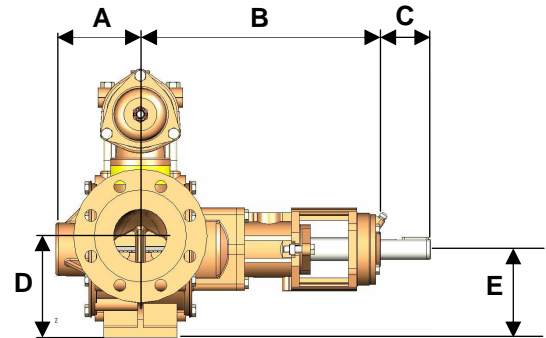
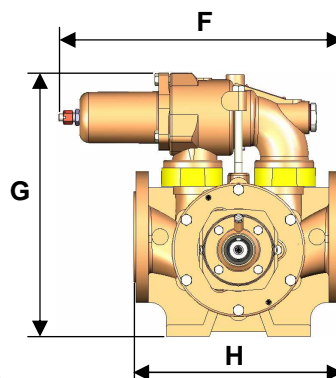

### OPERATING LIMITS

	STANDARD MATERIALS	AVAILABLE OPTIONS
<b>Minimum temperature °C (°F)</b>	-10 (14)	
<b>Maximum temperature °C (°F)</b>	200 (392)	250 (482) with FKM HT O rings
<b>Maximum viscosity cSt (SSU)</b>	200000 (960000)	
<b>Maximum differential pressure bar (psi)</b>	12 (174)	6 (87) with metallic vanes
<b>Maximum outlet pressure barg (psig)</b>	14 (203)	
<b>Maximum speed (rpm)</b>	1500 up to 6 bar, 1000 above	750 with metallic vanes

### MATERIALS OF CONSTRUCTION

Part No	PART NAME	STANDARD MATERIALS	AVAILABLE OPTIONS
101	Casing	Cast iron	
301	Rotor	Cast iron	SG Iron on 12 vanes rotors
317	Vanes	PEEK	Carbon steel (1), bronze
318	Push Rods	-	Carbon steel, PEEK (bronze vanes)
401	Cover	Cast iron	
407	Bushings	Carbon	
501	Shaft	Carbon steel	
508	Shaft end key	Carbon steel	
536	Rotor key	Carbon steel	
712	End Cover	Cast iron	
725	Outboard bearing holder	Cast iron	
705	Outboard bearing cover	Cast iron	
801	Relief valve casing	Cast iron	
823	Relief valve plug	Cast iron	
827	Relief valve cover	Cast iron	
	Bolts	Carbon steel	
	O rings	FKM	PTFE coated FKM, FKM HT
600	Mechanical seal (Mouvex)	Carbon/FKM/stainless steel/FKM	Carbon/FEP/ st.steel /FEP Carbon/FKM HT/st.steel/FKM HT Bronze/FKM/ st.steel /FKM Bronze/FEP/ st.steel /FEP Bronze/FKM HT/ st.steel /FKM HT Tungsten Carbide/FKM/ Tung. Carb./FKM Tung. Carb./FEP/ Tung. Carb./FEP Tung. Carb./FKM HT/ Tung. Carb./FKM HT Standardized Seal (single or double) PTFE Packing Graphite Packing

(1) With chrome coated casing (friction zone only)

