

MOUVEX
MODEL :

PARTS LIST
AR O

P.L. : 1003-L01

(See Instructions **1003-L00** for Installation, Operation and Maintenance)

Section	1003
Effective	November 2011
Replaces	September 2011

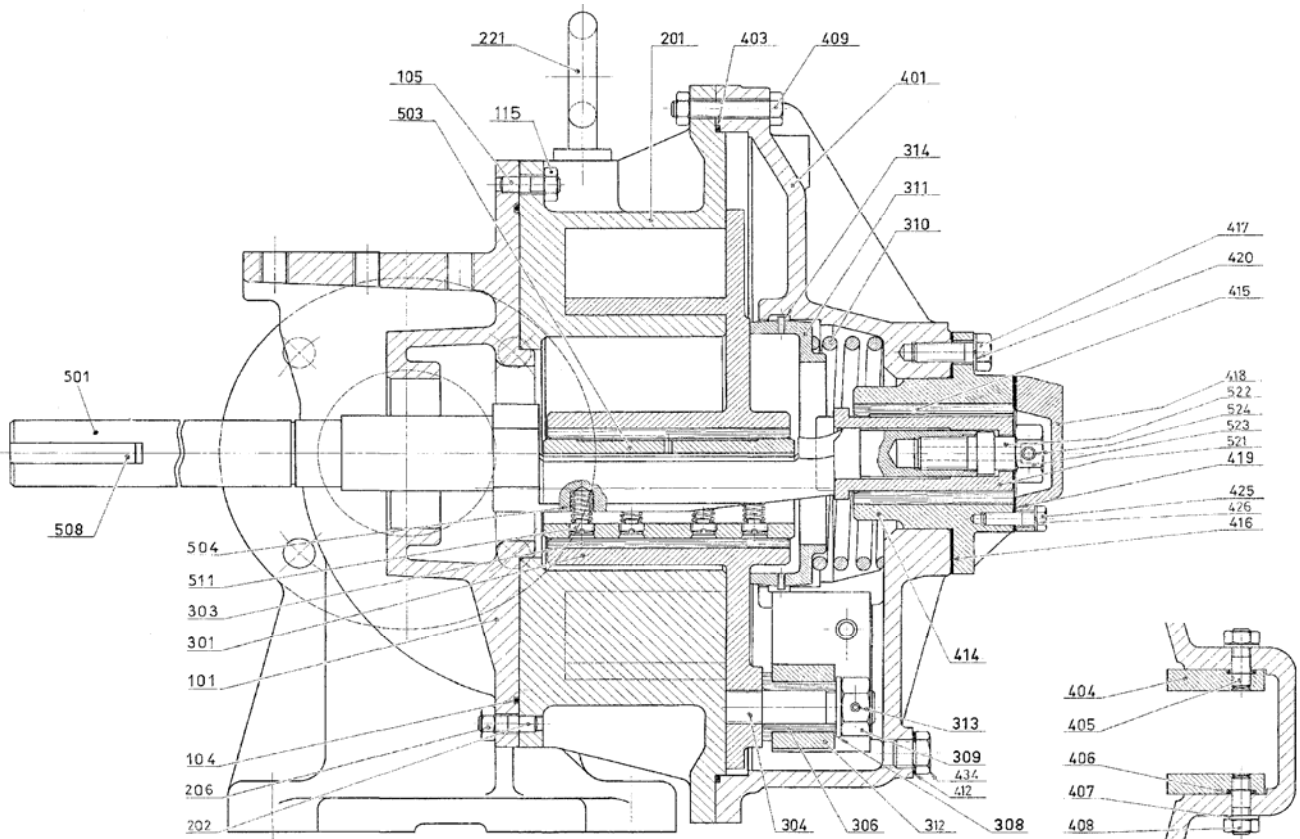

Reference			Description	Quantity		Article code	Wear parts
Ass.	Part	Available		Order	In Pump	AR O	
98		◆	Full set of screws	1		300960.00	
	105		Stud		(10)		
	115		Nut		(10)		
	202		Stud		(2)		
	206		Nut		(2)		
	409		Screw		(15)		
	409a		Nut		(15)		
	417		Screw		(6)		
	420		Washer		(6)		
	425		Screw		(5)		
	426		Washer		(5)		
99		◆	Full set of seals - FKM	1		300962.00	
99		◆	Full set of seals - (Heating jacket)	1		305180.00	
	104		Gasket		(1)		
	403		Front cover seal		(1)		
	406		Seal		(4)		
	416		Gasket		(1)		
	419		Seal		(1)		
	1002		Seal		(1)		

(◆) Sets of parts or (▲) parts available to order.

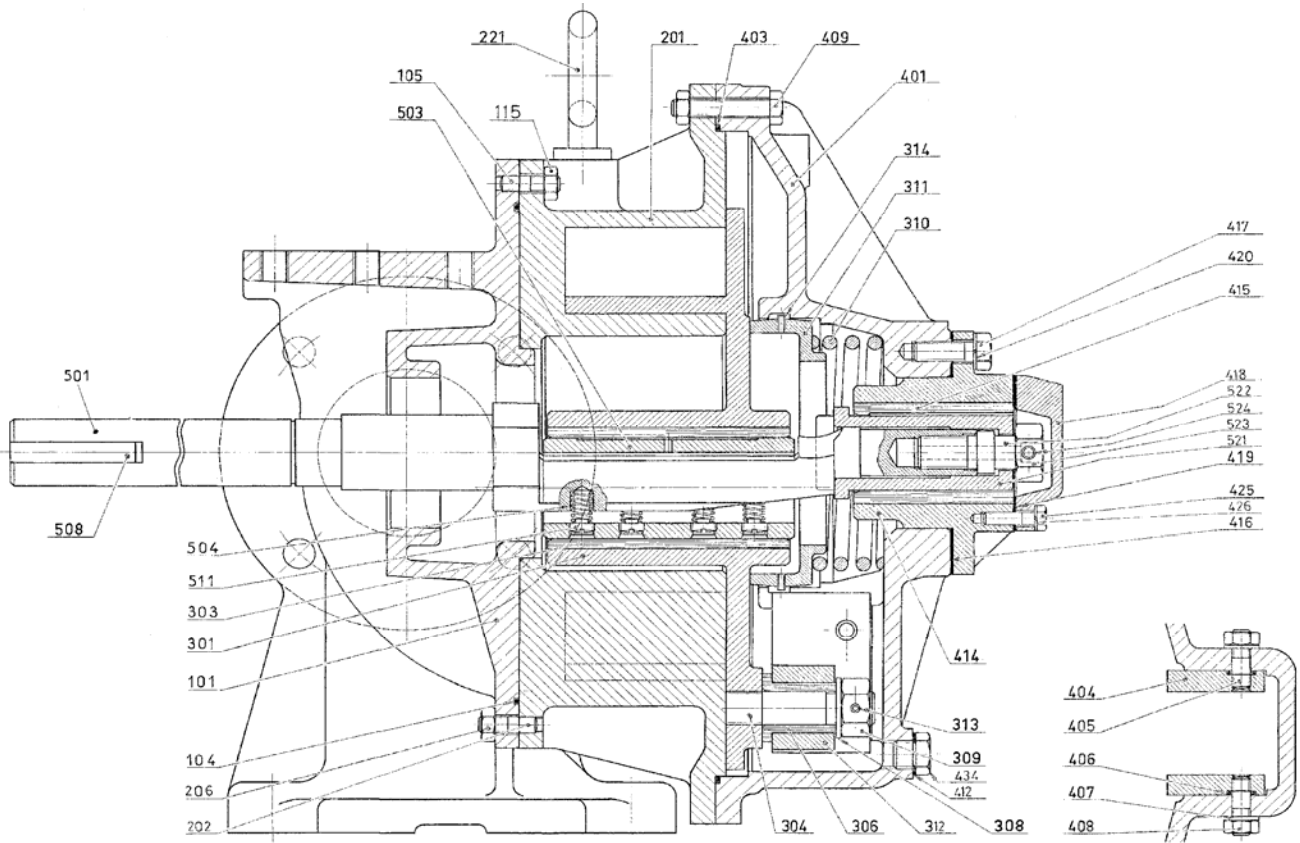

Reference			Description	Quantity		Article code	Wear parts
Ass.	Part	Available		Order	In Pump	AR O	
100	101	◆	Main body, complete	1		300952.00	
	105		Main body		(1)		
	115		Stud		(10)		
	817	◆	Mounting kit	1		301048.00	
	813		Nut		(2)		
	814		Stud		(2)		
	815		Washer		(2)		
200	201	◆	Cylinder, complete	1		300953.01	•
	202		Cylinder		(1)		
	206		Stud		(2)		
	206		Nut		(2)		
	221		Hoisting ring		(1)		
300		◆	Complete piston - Bronze bushing	1		300954.00	•
300		◆	Complete piston - Carbon bushing	1		307725.00	•
300		◆	Complete piston (drilled) - Bronze bushing	1		310794.00	•
300		◆	Complete piston (drilled) - Carbon bushing	1		310798.00	•
	3010		Piston + Block pin		(1)		
	303	▲	Piston bushing (bronze)	1		203664	•
	303	▲	Piston bushing (carbon)	1		211659	•
	315		Screw (for drilled piston)		(1)		
	398	◆	Slide block, complete	1		305230.00	
	308		Washer		(1)		
	309		Nut		(1)		
	307	◆	Slide block + pin + bushing	1		301049.00	•
	306		Bushing		(1)		
	312		Slide block		(1)		
	313		Pin		(1)		
399	310	◆	Guide block, complete	1		300956.00	
	311		Spring		(1)		
	314		Piston rear spring seat		(1)		
	314		Pin		(2)		

(◆) Sets of parts or (▲) parts available to order.

Reference			Description	Quantity		Article code	Wear parts
Ass.	Part	Available		Order	In Pump	AR O	
400		◆	Complete front cover - FKM	1		301681.00	
460		◆	Complete front cover with jacket	1		304667.00	
	401		Front cover		(1)		
	461		Jacketed front cover		(1)		
	462		Jacket drain plug		(2)		
	402	◆	Front bushing set - FKM	1		300963.00	•
	402	◆	Front bushing set - Teflon encapsulated FKM	1		304672.00	•
	404		Guide		(2)		
	405		Stud		(4)		
	406		Seal		(4)		
	407		Washer		(4)		
	408		Nut		(4)		
	411	◆	Front cover drain plug + seal	1		300897.00	
	412		Seal		(1)		
	434		Drain plug		(1)		
	403	▲	Front cover seal - FKM	1		200843	
413		◆	Front cover bearing complete - Bronze bushing	1		300958.00	
413		◆	Front cover bearing complete - Carbon bushing	1		308308.00	
	414		Front cover bearing		(1)		
	415	▲	Bearing bushing - Bronze	1	(1)	201801	•
	415	▲	Bearing bushing - Carbon	1	(1)	211660	•
	416		Gasket		(1)		
	417		Screw		(6)		
	418		Plug		(1)		
	419		Seal		(1)		
	420		Washer		(6)		
	425		Screw		(5)		
	426		Washer		(5)		
500		◆	Shaft Blocdir complete	1		312278.00	
	501	▲	Shaft	1		219473	
	503	▲	Piston bearing	1		203669	•
	508	▲	Key	1		203859	
	598	◆	Bearing spring complete	1		300959.00	
	504		Spring		(4)		
	511		Screw		(4)		
	515	◆	Complete sleeve	1		301064.00	•
	521		Sleeve		(1)		
	522		Screw		(1)		
	523		Nut		(1)		
	524		Pin		(1)		

(◆) Sets of parts or (▲) parts available to order.

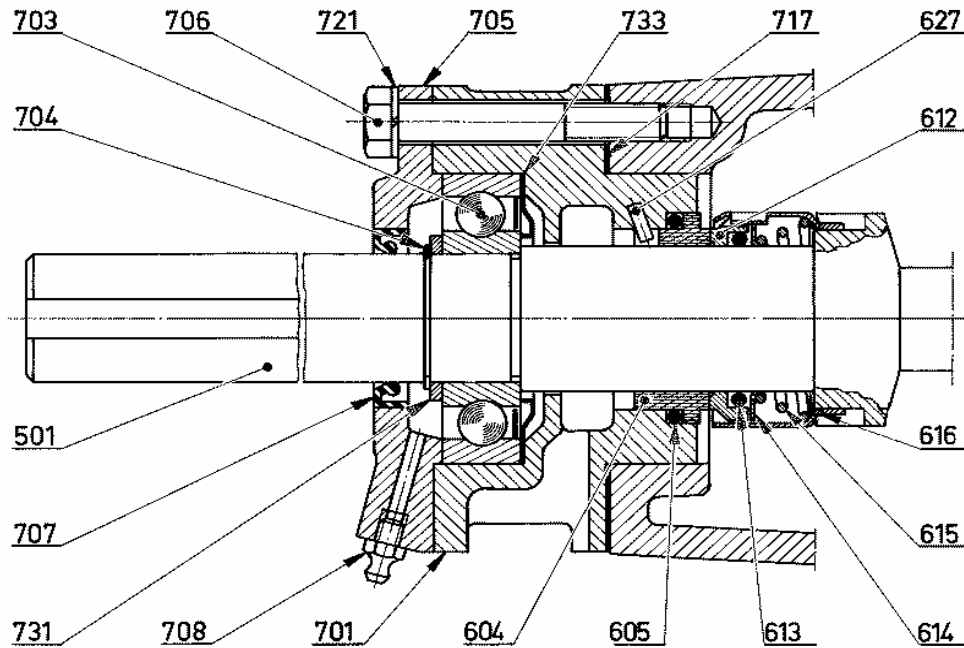

Reference			Description	Quantity		Article code	Wear parts
Ass.	Part	Available		Order	In Pump	AR O	
600		◆	Mechanical seal - Bloccdir C/I VT	1		300999.00	•
600		◆	Mechanical seal - Bloccdir C/I CVT	1		307562.00	•
600		◆	Mechanical seal - Bloccdir HR VT	1		303706.00	•
600		◆	Mechanical seal - Bloccdir HR CVT	1		307567.00	•
	610		Stationary seal face complete - Bloccdir		(1)		
	604		Stationary seal face		(1)		
	605		Seal		(1)		
	697		Rotating part - Bloccdir		(1)		
	612		Seal housing		(1)		
	613		Seal		(1)		
	614		Spring guide		(1)		
	615		Spring		(1)		
	616		Cage		(1)		
	619		Seal mounting tool (for CVT)		(1)		
700		◆	Ball bearings complete	1		300987.00	
	627	▲	Pin	1		200144	
	701		Bearing cage		(1)		
	703	▲	Ball bearing	1		200559	•
	705		Bearing cover		(1)		
	706		Screw		(6)		
	708		Grease nipple		(1)		
	721		Washer		(6)		
	797	◆	Ball bearing washers and gasket set	1		301067.00	
	704		Ring		(1)		
	707		Lip seal		(1)		
	717		Cage seal		(1)		
	731		Washer		(1)		
	733		Protection circlip		(1)		

CVT : FEP encapsulated FKM

Mechanical seal :

C/I : Carbon/stainless - HR : Tungsten carbide/tungsten carbide

(◆) Sets of parts or (▲) parts available to order.

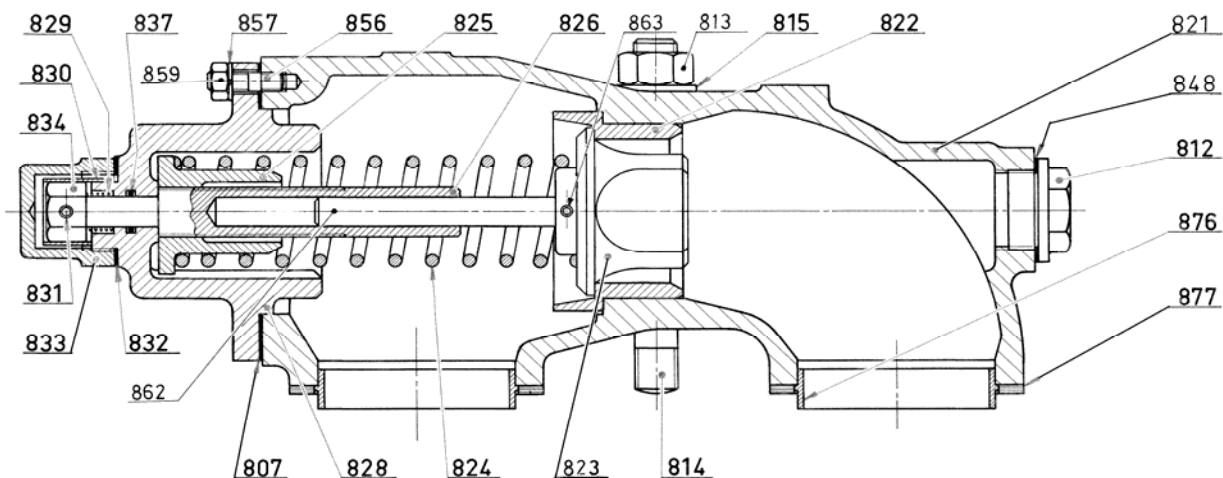

Reference			Description	Quantity		Article code	Wear parts
Ass.	Part	Available		Order	In Pump	AR O	
820		◆	Bypass C/3 complete - FKM	1		306472.00	
820		◆	Bypass C/4 complete - FKM	1		306475.00	
	870	◆	Bypass body complete	1		301092.00	
	812		Plug		(1)		
	821		Bypass body		(1)		
	822		Seat		(1)		
	848		Seal		(1)		
	856		Stud		(6)		
	857		Washer		(6)		
	859		Nut		(6)		
	824	▲	Spring n°3	1		201208	
	824	▲	Spring n°4	1		201205	
	869	◆	Bypass cap and gasket	1		300740.00	
	832		Seal		(1)		
	833		Cap		(1)		
	878	◆	Centering set	1		301087.00	
	876		Centering piece		(2)		
	877		Centering gasket		(2)		
	897	◆	Adjusting screw/valve set - FKM	1		306488.00	
	807		Seal		(1)		
	825		Spring guide		(1)		
	826		Adjusting screw		(1)		
	828		Nut		(1)		
	829		Spring		(1)		
	830		Stopper		(1)		
	831		Pin		(1)		
	834		Adjustment nut		(1)		
	837		Seal		(1)		
	864	◆	Complete valve	1		301097.00	
	823		Compensated valve		(1)		
	863		Valve securing pin		(1)		
	866		Valve stem		(1)		
	899	◆	Bypass gasket set - FKM	1		301024.00	
	807		Seal		(1)		
	829		Spring		(1)		
	831		Pin		(1)		
	832		Seal		(1)		
	837		Seal		(1)		
	846		Seal		(1)		
	848		Seal		(1)		
	877		Centering gasket		(2)		

(◆) Sets of parts or (▲) parts available to order.

Reference			Description	Quantity		Article code	Wear parts
Ass.	Part	Available		Order	In Pump	AR O	
VARIATIONS							
			COMPLETE COMPENSATED DOUBLE BYPASS	The body is different to the standard compensated bypass. The other parts are the same but doubled			
820a		◆	Double bypass C/3 complete - FKM	1		306483.00	
820a		◆	Double bypass C/4 complete - FKM	1		306486.00	
	870a	◆	Double bypass body complete	1		301099.00	
	821a		Double bypass body		(1)		
849		◆	Complete stirrup	1		301653.01	
	852		Stirrup		(1)		
	853		Stud or Screw		(1)		
	854		Plug		(2)		
	855		Seal		(2)		
	888		Nut		(1)		
To mount a bypass in place of a stirrup will require :							
817	817	◆	Mounting kit	1		301048.00	
	813		Nut		(2)		
	814		Stud		(2)		
	815		Washer		(2)		

(◆) Sets of parts or (▲) parts available to order.

Keep this parts lists with Installation, Operation and Maintenance Instructions.

To order the required spare parts, indicate the appropriate CUM numbers.



Z.I. la Plaine des Isles - 2 rue des Caillottes F-89000 AUXERRE - FRANCE

Tel : +33 (0)3 86 49 86 30 • Fax : +33 (0)3 86 49 87 17

contact@mouvex.com • www.mouvex.com